



LED Downlight HM

Features

- High lumen efficacy, 100 lm/W
- Optimal heat management
- Broad range of sizes: 2.5", 3", 4", 6" or 8"
- IP44 protection rating

Benefits

- Up to 60% energy savings compared to CFL
- Lasts 5 times longer than CFL
- Easily retrofit conventional fixtures with LED
- Resistant to humidity

Application



Specification

Item Code	Item Description	Power (W)	Power Factor	Lumen (lm)	Efficacy (lm/W)	Input Current (mA)	Beam Angle (°)	CRI	CCT (K)	Lifetime (L70B50)	MOQ (pcs)
140048184	LEDDownlightRc-HM R82-5W-3000-WH-GP	5	0.70	330	66	30	75	≥80	3000	30Khrs	540
140048185	LEDDownlightRc-HM R82-5W-4000-WH-GP	5	0.70	370	74	30	75	≥80	4000	30Khrs	540
140048186	LEDDownlightRc-HM R82-5W-5700-WH-GP	5	0.70	400	80	30	75	≥80	5700	30Khrs	540
140048187	LEDDownlightRc-HM R100-6W-3000-WH-GP	6	0.70	420	70	40	75	≥80	3000	30Khrs	540
140047841	LEDDownlightRc-HM R100-6W-4000-WH-GP	6	0.70	480	80	40	75	≥80	4000	30Khrs	540
140048188	LEDDownlightRc-HM R100-6W-5700-WH-GP	6	0.70	520	87	40	75	≥80	5700	30Khrs	540
140048189	LEDDownlightRc-HM R120-9W-3000-WH-GP	9	0.70	700	78	70	80	≥80	3000	30Khrs	540
140047842	LEDDownlightRc-HM R120-9W-4000-WH-GP	9	0.70	800	89	70	80	≥80	4000	30Khrs	540
140048190	LEDDownlightRc-HM R120-9W-5700-WH-GP	9	0.70	850	94	70	80	≥80	5700	30Khrs	540
140049938	LEDDownlightRc-HMP R120-9W-3000-WH-GP	9	0.95	700	78	48	80	≥80	3000	30Khrs	540
140049939	LEDDownlightRc-HMP R120-9W-4000-WH-GP	9	0.95	750	83	48	80	≥80	4000	30Khrs	540
140049940	LEDDownlightRc-HMP R120-9W-5700-WH-GP	9	0.95	800	89	48	80	≥80	5700	30Khrs	540
140048191	LEDDownlightRc-HM R175-14W-3000-WH-GP	14	0.80	1100	79	90	80	≥80	3000	30Khrs	540
140047843	LEDDownlightRc-HM R175-14W-4000-WH-GP	14	0.80	1200	86	90	80	≥80	4000	30Khrs	540
140048192	LEDDownlightRc-HM R175-14W-5700-WH-GP	14	0.80	1400	100	90	80	≥80	5700	30Khrs	540
140049941	LEDDownlightRc-HMP R175-14W-3000-WH-GP	14	0.95	1220	87	70	80	≥80	3000	30Khrs	540
140049942	LEDDownlightRc-HMP R175-14W-4000-WH-GP	14	0.95	1320	94	70	80	≥80	4000	30Khrs	540
140049943	LEDDownlightRc-HMP R175-14W-5700-WH-GP	14	0.95	1410	101	70	80	≥80	5700	30Khrs	540
140048193	LEDDownlightRc-HM R210-29W-3000-WH-GP	29	0.95	2300	79	140	80	≥80	3000	30Khrs	320
140047844	LEDDownlightRc-HM R210-29W-4000-WH-GP	29	0.95	2500	86	140	80	≥80	4000	30Khrs	320
140048194	LEDDownlightRc-HM R210-29W-5700-WH-GP	29	0.95	2700	93	140	80	≥80	5700	30Khrs	320
140048195	LEDDownlightRc-HM R210-42W-3000-WH-GP	42	0.95	3300	79	210	80	≥80	3000	30Khrs	320
140048196	LEDDownlightRc-HM R210-42W-4000-WH-GP	42	0.95	3700	88	210	80	≥80	4000	30Khrs	320
140048197	LEDDownlightRc-HM R210-42W-5700-WH-GP	42	0.95	4200	100	210	80	≥80	5700	30Khrs	320

Technical Specifications	
On / Off Cycles	50,000
Colour Consistency (SDCM)	6
Dimmable	No
Finishing Colour	White
IP	IP20, IP44 for exposed parts
Driver Integrated (Yes/No)	No
Glow Wire Test	650°C
Driver Failure Rate	1% at 5000h
Weight (kg/pc)	0.21 / 0.27 / 0.43 / 0.39 / 0.73 / 0.71 / 1.2

Electrical Supply	
Frequency (Hz)	50/60
Voltage (V)	220-240
AC/DC	AC

Mechanical Properties	
Housing Material	Die-cast Aluminum
Optical Material	Aluminum Coated PC

Application Conditions	
Operating Temperature	-10-40°C
Application Temperature	25°C
Storage Environment	-25-50°C

CE CB

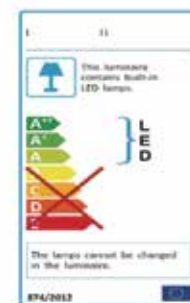

Packaging Information

Item		Single Box(1pc/box)		Packaging Unit		
Item Code	Item Description	Dimensions(mm) (LxWxH)	Gross Weight (kg)	Dimensions(mm) (LxWxH)	Gross Weight (kg)	Packing Qty (pcs/unit)
140048184	LEDDownlightRc-HM R82-5W-3000-WH-GP	128x128x80	0.28	400x270x265	5.09	18
140048185	LEDDownlightRc-HM R82-5W-4000-WH-GP	128x128x80	0.28	400x270x265	5.09	18
140048186	LEDDownlightRc-HM R82-5W-5700-WH-GP	128x128x80	0.28	400x270x265	5.09	18
140048187	LEDDownlightRc-HM R100-6W-3000-WH-GP	150x150x93	0.41	465x315x305	7.42	18
140047841	LEDDownlightRc-HM R100-6W-4000-WH-GP	150x150x93	0.41	465x315x305	7.42	18
140048188	LEDDownlightRc-HM R100-6W-5700-WH-GP	150x150x93	0.41	465x315x305	7.42	18
140048189	LEDDownlightRc-HM R120-9W-3000-WH-GP	135x135x100	0.45	290x150x320	2.70	6
140047842	LEDDownlightRc-HM R120-9W-4000-WH-GP	135x135x100	0.45	290x150x320	2.70	6
140048190	LEDDownlightRc-HM R120-9W-5700-WH-GP	135x135x100	0.45	290x150x320	2.70	6
140049938	LEDDownlightRc-HMP R120-9W-3000-WH-GP	150x150x80	0.57	316x316x184	4.56	8
140049939	LEDDownlightRc-HMP R120-9W-4000-WH-GP	150x150x80	0.57	316x316x184	4.56	8
140049940	LEDDownlightRc-HMP R120-9W-5700-WH-GP	150x150x80	0.57	316x316x184	4.56	8
140048191	LEDDownlightRc-HM R175-14W-3000-WH-GP	188x188x120	0.96	584x396x140	5.76	6
140047843	LEDDownlightRc-HM R175-14W-4000-WH-GP	188x188x120	0.96	584x396x140	5.76	6
140048192	LEDDownlightRc-HM R175-14W-5700-WH-GP	188x188x120	0.96	584x396x140	5.76	6
140049941	LEDDownlightRc-HMP R175-14W-3000-WH-GP	210x210x102	1.07	436x436x228	8.56	8
140049942	LEDDownlightRc-HMP R175-14W-4000-WH-GP	210x210x102	1.07	436x436x228	8.56	8
140049943	LEDDownlightRc-HMP R175-14W-5700-WH-GP	210x210x102	1.07	436x436x228	8.56	8
140048193	LEDDownlightRc-HM R210-29W-3000-WH-GP	250x250x145	1.60	520x267x455	9.60	6
140047844	LEDDownlightRc-HM R210-29W-4000-WH-GP	250x250x145	1.60	520x267x455	9.60	6
140048194	LEDDownlightRc-HM R210-29W-5700-WH-GP	250x250x145	1.60	520x267x455	9.60	6
140048195	LEDDownlightRc-HM R210-42W-3000-WH-GP	250x250x145	1.60	520x267x455	9.60	6
140048196	LEDDownlightRc-HM R210-42W-4000-WH-GP	250x250x145	1.60	520x267x455	9.60	6
140048197	LEDDownlightRc-HM R210-42W-5700-WH-GP	250x250x145	1.60	520x267x455	9.60	6

Dimensional Drawing

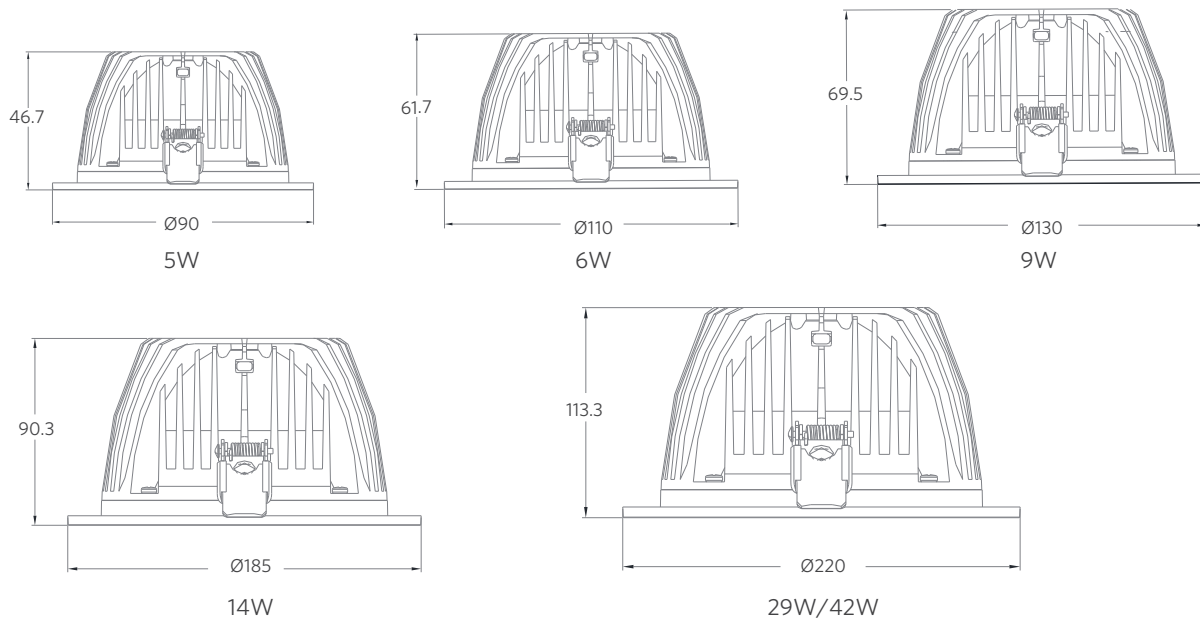

Cut-out Drawing

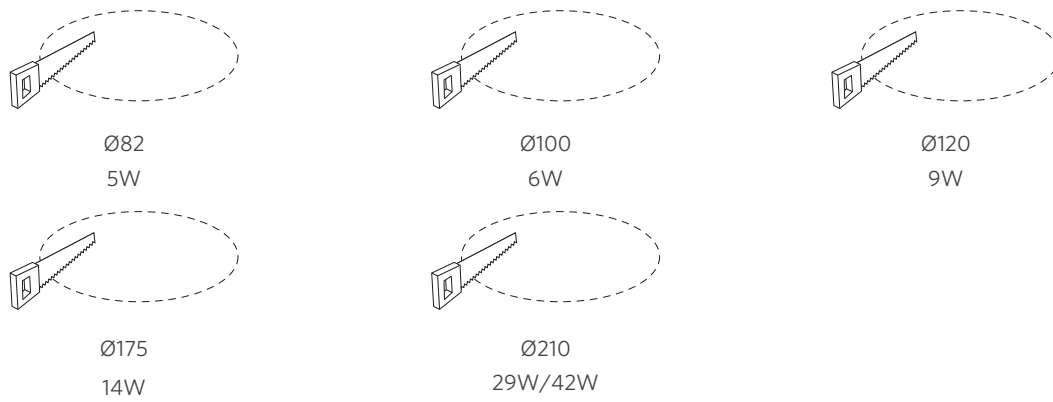

Photometric Data

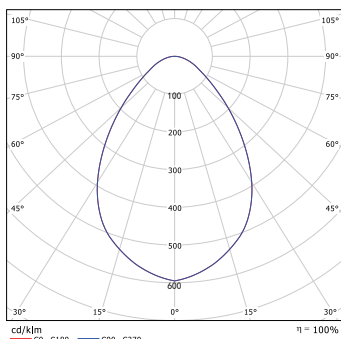

75°(5W/6W)

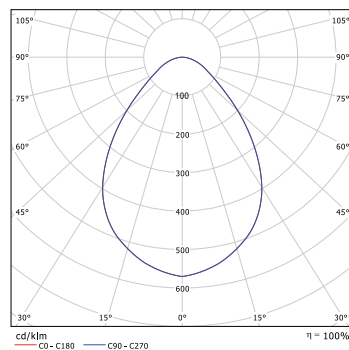

80°(9W/14W/29W/42W)

OPPLE SHANGHAI OFFICE
1999 Zhangheng Road, Building 3
Shanghai 201203 China

T +86 21 3855 0000
E intersales@opple.com

OPPLE.COM